

Washing machine

Private household / apartment building

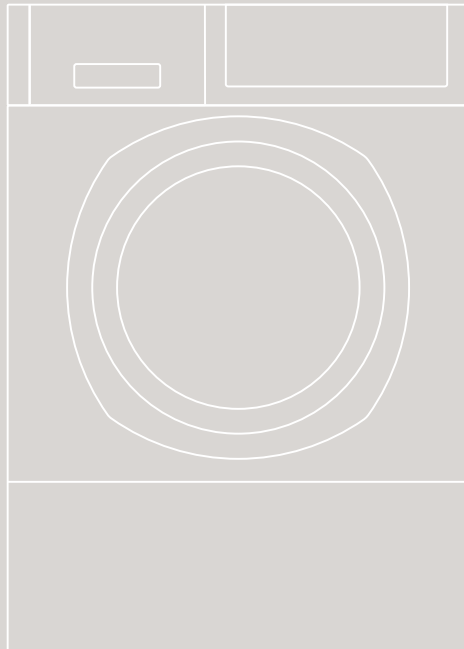

Operating instructions



Do not operate the appliance until you have read these instructions.

08/2024
Instruction number 563 219.AA

Symbols



Read the instructions.



Warnings are marked with a warning triangle. The text gives information how a dangerous situation can be avoided. Signal words indicate the severity of the danger, if not avoided.



WARNING

means that possible personal injuries, and potentially life-threatening injuries may occur.



CAUTION

means that property damage may occur.



Dear Customer

We are pleased that you have chosen a Schulthess washing machine.

Your new washing machine is the result of many years of development work. The highest quality requirements, both in development and manufacture, guarantee a long lifetime.

Its design meets all the demands of modern laundry care and offers you a varied and individual choice of programmes.

The most economical use of water, energy and detergent helps protect our environment and ensures that your washing machine runs as economically as possible.

Please read these instructions carefully to enable you to use all the possibilities and advantages of your new washing machine. Please note in particular the safety instructions and the enclosed warranty and customer service booklet.

We hope you will be happy with your new Schulthess appliance.

**Your
Schulthess Maschinen AG**

CONTENTS

SAFETY AND SAFETY MEASURES	6
DISPOSAL	9
APPLIANCE DESCRIPTION	10
Control and display panel	11
Detergent drawer	12
WASHING	13
Initial wash cycle (without laundry)	13
Preparing appliance	13
Selecting the programme	13
Changing programme before the programme has started	14
Starting the programme	14
Skipping to the next programme step	14
Adding laundry	14
Interrupting the programme	14
Cancelling the programme	14
Ending programme after rinse cycle has stopped	14
Programme end	15
WASH PROGRAMMES	16
PROGRAMME GROUPS	21
Favourites	21
Homecare	21
Businesswear	21
Softcare	21
Activewear	21
Antibac	22
Babycare	22

PROGRAMME OPTIONS	23
Express	23
Prewash	23
Intensive.....	23
Rinse +	23
Temperature	23
Speed.....	23
Rinse stop	24
Soak.....	24
Supersilent.....	24
Time preset	24
SETTINGS	25
Settings menu.....	25
PREPAID CARD / WASHMASTER CARD	29
CLEANING AND MAINTENANCE	30
Cleaning the appliance	30
Checking the water inlet hose.....	30
Frost protection	30
Cleaning the detergent drawer	31
Emergency emptying.....	31
Cleaning the filters in the water inlet.....	32
PROBLEMS	34
CUSTOMER SERVICE	41
EC-DECLARATION OF CONFORMITY	42

SAFETY AND SAFETY MEASURES



The enclosed instructions contain important information on the installation, use and safety of your washing machine. Keep them in a safe place for other users or subsequent owners.

- Read the instructions carefully before using the appliance.
- Keep the instructions close to the appliance for further reference.

This appliance meets the stringent safety regulations for electrical appliances.

- Follow the safety instructions in the operating and installation instructions.

Use in accordance with the intended purpose

This washing machine is intended exclusively for washing machine-washable fabrics in the home.

The appliance can be used by children aged from 8 years and above and adults with reduced physical, sensory or mental capabilities or lack of experience and knowledge if they have been given supervision or instruction concerning use of the appliance in a safe way and understand the hazards involved. Children must not play with the appliance. Cleaning and user maintenance must not be carried out by children without supervision.

Safety during operation and use

WARNING Risk of electric shock!

- Do not operate an appliance with visible damage.
- Only touch the mains plug with dry hands.
- Only pull on the plug, never on the cable, as this could be damaged.
- Never spray the appliance with water and never use a steam cleaner.
- If the appliance is tilted, do not touch it under any circumstances while it is still connected to the power supply.

Repairs may only be carried out by trained specialist personnel and defective components may only be replaced with original spare parts from the appliance manufacturer.

Incorrect repairs or third-party spare parts can cause considerable material damage and danger to the user.

Modifications to the appliance are only permitted in consultation with the manufacturer.

- If the mains connection cable is damaged, it must be replaced by a specialist using the appropriate replacement cable (available from the manufacturer or customer service).
- Never immerse the Aquastop valve in water.
- Always disconnect the power supply before carrying out maintenance work.
- If the appliance is not to be used for a longish period of time, it must be disconnected from the power supply.

 **WARNING Risk of injury!**

If you climb onto the washing machine, it may tip over and cause injury.

- Do not climb onto the appliance.
- Do not sit, lean or support yourself on the loading door.

Reaching into the rotating drum can cause injury to hands.

- Never reach into the rotating drum.
- Wait until the drum has come to a standstill.

When washing at high temperatures, contact with hot suds can cause scalding.

- Before washing, check that the pump cover is inserted and screwed tight.
- Never loosen the pump cover while a wash programme is running.

When a wash programme is cancelled, the laundry may still be very hot. Hot water can also escape from the rubber seal at the door opening.

- Let the laundry cool down before removing it.

When lifting the washing machine, protruding components (e.g. loading door, cover plate) may break off.

- Do not lift the appliance by protruding components.

If a puddle of water has formed on the floor near the appliance (broken hose or similar), wipe it dry and rectify the cause (see **PROBLEMS**).

 **WARNING Risk of fire!**

Improper use of laundry starch and the washing of fabrics containing solvents can produce explosive substances.

- Never use detergents containing solvents.

- Rinse fabrics containing solvent-based cleaning agents or flammable chemicals thoroughly in clear water before washing by hand.
- Only add laundry starch during the final rinse (finishing).
- Detergents, washing aids and other additives (water softeners, colouring and decolouring agents, starch, etc.) must be expressly approved for use in a household washing machine (see manufacturer's instructions).

Safety for children

 **WARNING Risk of injury!**

Children can get into life-threatening situations or injure themselves when playing with the washing machine.

- Children under the age of 3 should be kept away from the machine unless they are supervised at all times.
- Do not allow children to play in, on or near the washing machine.
- Activate the child lock if required.

Children can become trapped in appliances and put their lives in danger. Make disused appliances unusable:

- Pull out the mains plug.
- Cut the mains cable and remove together with the plug.
- Destroy the door lock.

Children can wrap themselves in packaging/film and packaging parts while playing or pull them over their heads and suffocate.

- Keep packaging material away from children.

Detergents and care products can lead to poisoning if ingested.

- Keep detergents and laundry care additives out of the reach of children.

Children can choke on small parts.

- Keep small parts away from children.

Safety during installation

Warning Risk of injury!

When placing the appliance on a plinth, it must be secured in accordance with the installation instructions, otherwise the appliance may tip over and fall.

- Have the appliance installed by a specialist in accordance with the installation instructions.
- Do not connect an appliance with visible damage.

Pay attention when washing

- Ensure that the transport securing devices have been removed. Temporarily refit them when transporting the machine again.
- The water used for washing and rinsing is not drinking water. Drain the caustic solution into a waste water system designed for this purpose.
- Foreign objects (e.g. paper clips, coins, nails, etc.) can cause damage. Remove any foreign objects from the laundry before washing. Check the drum and detergent drawer before washing. At the end of the programme, remove any foreign objects from the sealing ring on the door opening.
- When operating the appliance at an altitude of more than 2000 m above sea level, the temperature limiter must be activated to prevent boiling (see service instructions or ask customer service or a specialist dealer).
- Check the water hoses at regular intervals to replace them in good time and prevent water damage.
- When closing the loading door, ensure that your fingers do not get trapped.

- Keep pets away from the appliance.
- Do not place any objects on the machine. These can slip and fall to the ground during spinning.
- If in doubt, ask your dealer or customer service.
- Never open the detergent drawer while a washing programme is running.
- Do not pull on the door while a washing programme is running.

DISPOSAL

Packaging from your new appliance

All packaging materials used are environmentally friendly and reusable. Return the packaging to the specialist dealer or supplier. Dispose of the packaging material properly.

Disposing of your old appliance

Disused electrical and electronic appliances should be collected, recyclable materials recovered and harmful substances disposed of in an environmentally friendly manner. For this reason, an advance disposal fee is levied on every household appliance and charged directly to the end user. This is required by Swiss law.

The advance recycling fee (vRG)

The advance recycling fee is already included in the price of a new appliance.

This contribution is used to finance the current disposal of old appliances. This is why all household appliances can be handed in for disposal free of charge, even if they have not been purchased new.

Your retailer or one of the 400 official SENS collection points will accept used appliances (WWW.SENS.CH or ask your local authority).

An additional fee may be charged for the collection of appliances from households.

APPLIANCE DESCRIPTION

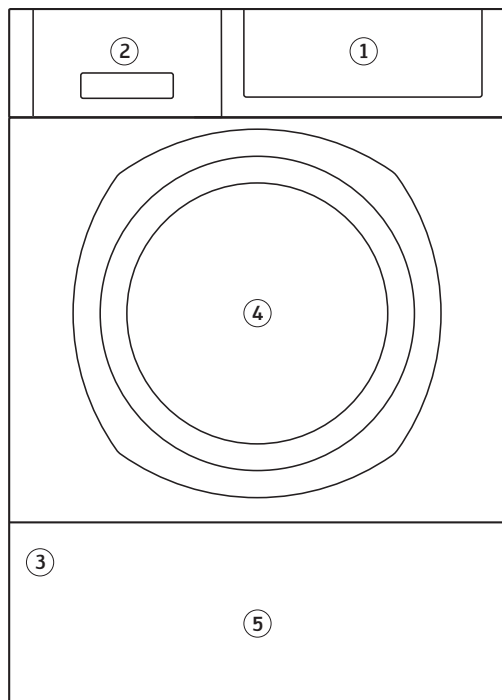

- ① Control and display panel
- ② Detergent drawer
- ③ Type plate (open appliance door, type plate is located at the top on inside of door)
- ④ Loading door
- ⑤ Plinth cover
- ⑥ Selection buttons





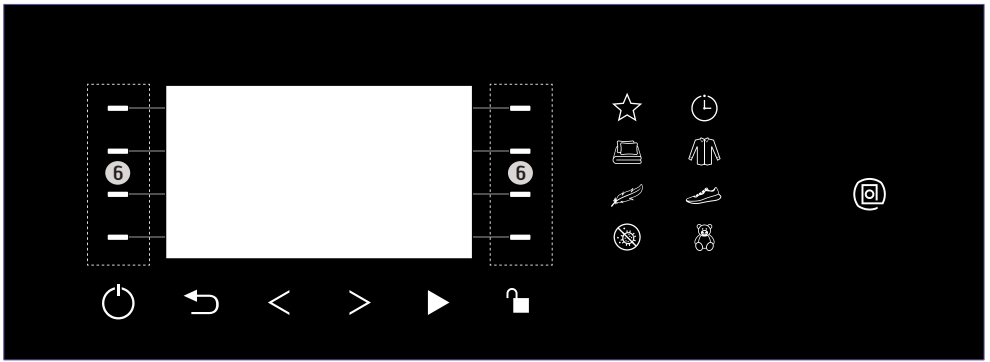



Illustration may vary depending on model.

Control and display panel











Example: Display EFH

Display and buttons

-  On/Off
-  Back
-  Scroll backwards
-  Scroll forwards
-  Start
-  Open the door
-  Settings
-  Language (temporary)/
Settings
-  1/3
Page number in programme
menu

Additional buttons

-  Favourites
-  Time preset
-  Homeclean
-  Businesswear
-  Softcare
-  Activewear
-  Antibac
-  Babycare
-  Connectivity

Not all buttons are available for all models.

Detergent drawer

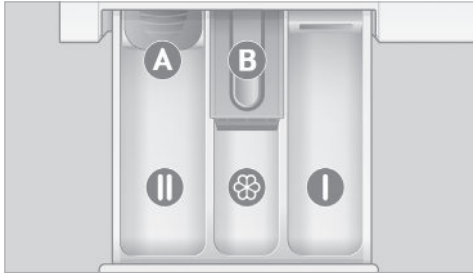

- II** Main detergent, modular detergent, bleach, starch, water softener
- Flower icon** Fabric softener and care additives for the final rinse cycle
- I** Prewash/soaking agent
- A** Flap for liquid detergent
- B** Unlock button

Pull out detergent drawer completely

- The detergent drawer can be removed by lightly pressing **BUTTON B** (see **CLEANING AND MAINTENANCE / CLEANING THE DETERGENT DRAWER**).

Detergent dosage

- See **WASHING INSTRUCTIONS**.

Liquid detergent

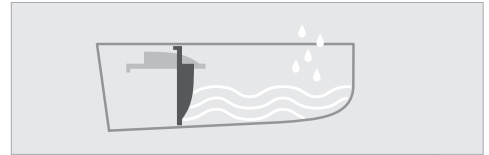

- Pull **FLAP A** downwards.

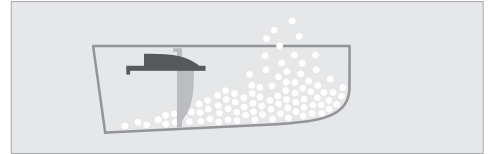

- For washing powder and tablets, slide the flap upwards and backwards.

Notice

Liquid detergent can thicken due to slow draining and lead to blockages.

When washing with a preset time, pour liquid detergent into a dosing ball and place it in the drum with the laundry.

- Do not use liquid detergent for prewash or pre-rinse programmes, use washing powder instead.

WASHING

- Install the appliance in accordance with the installation instructions.
- Do not connect an appliance with visible damage.
- Ensure that the transport securing devices have been removed.

Initial wash cycle (without laundry)

The washing machine was thoroughly inspected before leaving the factory.

- Carry out an initial wash cycle without laundry to remove any test water residues.

Preparing appliance

- Screw the pump cover tight.
- Switch on the power supply.
- Open the water tap.

Appliance switch-on

- Press **On/Off**. After starting up, the main menu is displayed.

The **ARROW** buttons can be pressed to call up **additional menu pages**.

Adding detergent

- Pull the detergent drawer out as far as it will go.
- Pour half a measuring cup of heavy-duty detergent into **COMPARTMENT II** (do not use mild or wool detergent to avoid excessive foaming).

Opening the door

- Press the **OPEN THE DOOR** button. The loading door springs open.

Selecting the programme

- Select the desired programme by pressing the light bar.

The programme is displayed with programme duration, spin speed, maximum load quantity and selectable options.

Selecting the programme option

The options can also be used to adjust the programme to the specifics of the laundry (see **PROGRAMME OPTIONS** chapter).

- Select the desired option(s) by pressing the light bar or the relevant symbol. Selected options are displayed in colour.
- Press again to deselect the option
- Press the **SCROLL FORWARDS** arrow button to call up additional menu pages.

Loading laundry

- Ensure that there are no foreign objects (paper clips, coins, nails, etc.) in the drum and detergent drawer.
- Place the laundry evenly in the drum.
- Mix large and small laundry items.

Load measurement

(Not available on all models)

The weight of the laundry is measured during loading.

If the laundry weight is less than 50% of the maximum load, the washing time is reduced.

- Reduce the amount of detergent for smaller quantities of laundry (see recommendation on the display).

Notice

If the loading door is opened again after closing, the process must be repeated as the weight measurement is reset when the door is opened.

Closing the door

- Press the door shut until you hear the lock click into place.
- Ensure that no laundry items are trapped between the loading door and the rubber seal.



Adding detergent

- Follow the instructions at **APPLIANCE DESCRIPTION / DETERGENT DRAWER**.

CAUTION

Risk of water damage.

After filling, close the detergent drawer until you feel it click into place.

Changing programme before the programme has started

- Press the **BACK** button.
- Select the new programme with the options.

Starting the programme

- Press **START**.

Prepaid card / washMaster

For appliances with a payment system, the programme will only start after the payment has been debited (see **PREPAID CARD / WASHMASTER**).

Skipping to the next programme step

- Press and hold the light bar next to **FORWARD** until the desired programme step is displayed.

Adding laundry

- Press the **OPEN THE DOOR** button (**IS NOT LIT!**). The programme is stopped and the door is unlocked.
- Follow the instructions on the display.

Notice

The door can no longer be opened after the 10 seconds have elapsed. In this case, cancel the programme (see **WASHING / CANCEL PROGRAMME**) and repeat the process.

Interrupting the programme

- Press and hold the **ON/OFF** button until the following window is displayed:
- Press the light bar next to **STOP** to stop the programme. Press **CONTINUE** to continue the programme.

Cancelling the programme

- Press and hold the light bar next to **CANCEL** until **END** is displayed.
- The water is pumped out and the programme ends.

Ending programme after rinse cycle has stopped

The laundry remains in the final rinse water. You now have two options:

Remove laundry dripping wet after the rinse cycle has stopped

- Select **DRAIN**. The rinse water is pumped out and the laundry can be removed.

Spin the laundry after the rinse cycle has stopped

- Press **START**. The rinse water is pumped out and the laundry is spun.

- To adjust the speed before the spin cycle, press the light bar next to **SPEED** (see **PROGRAMME OPTIONS / SPEED**).

Programme end

The programme end is displayed.

When crease protection is switched on, the drum continues to rotate at short intervals at the end of the programme (see **SETTINGS / CREASE PROTECTION**).

- The door can be opened.

Removing laundry

- Press the **OPEN THE DOOR** button.
- Remove the laundry.

After washing

- Remove any foreign objects (e.g. paper clips) from the drum and rubber seal to avoid rust stains.



- Leave the door open or ajar after washing. Drying and ventilating the drum prevents the formation of odours and mould.
- Close the water tap.
- Press and hold the **ON/OFF** button until the display goes out.
- Disconnect the appliance completely from the power supply if it is not to be used for a long period of time.

CAUTION

If the tap is open and the power supply is interrupted, the flood protection built into the appliance is ineffective.

(Only applies to appliances without Aquastop: The water inlet is automatically blocked by the Aquastop valve when the programme ends.)

WASH PROGRAMMES

This overview contains the programmes for all appliance types. You can find the programme and consumption data for your machine on our website in the download center www.schulthess.ch/service/downloadcenter.

 Please always observe the care labelling of fabrics

Eco 40 – 60

Most efficient programme for cotton fabrics in accordance with Regulation (EU)



2017/1369



Eco 40 – 60

Jeans, jumpers, T-shirts, towels, bed linen, aprons, shirts, underwear

- coloured cottons, linen

Normally soiled cotton fabrics marked with care labels  or  can be washed with this programme in the same wash cycle (not suitable for laundry with sensitive colours, as undissolved detergent can cause stains).

The Eco 40 – 60 wash programme is used to ensure compliance with EU eco-design legislation. It is the most efficient in terms of combined energy and water consumption. The washing temperatures are lower and the programme lasts longer than the other Cotton programmes.

Basic programmes



30° Cotton

Jeans, jumpers, T-shirts

- coloured cottons



40° Cotton

Jeans, jumpers, T-shirts, socks

- coloured cottons



**40° Cotton
Powerclean**

Jeans, jumpers, T-shirts, socks

- coloured cottons, short wash process
- small and medium loads



60° Cotton

Bed linen, aprons, jeans, towels, shirts, underwear

- coloured cottons, linen



**60° Cotton
Powerclean**

Bed linen, aprons, jeans, towels, shirts, underwear

- coloured cottons, linen, short wash process
- small and medium loads



30° Easy care

Outerwear, T-shirts, shirts, sportswear









- easy care cottons, blended fabrics or fabrics with synthetic fibres



40° Easy care

Outerwear, shirts, blouses, T-shirts, socks

- easy care cottons, blended fabrics or fabrics with synthetic fibres

	60° Easy care	Outerwear, shirts, blouses, aprons <ul style="list-style-type: none"> • easy care cottons, blended fabrics or fabrics with synthetic fibres
	40° Mixed laundry	T-shirts, shirts, jumpers <ul style="list-style-type: none"> • cottons, blended fabrics and synthetic fibres
	40° Delicates	Curtains, dresses, blouses, skirts, tights, bras <ul style="list-style-type: none"> • particularly delicate fabrics made of cotton or blended fabrics, synthetics, viscose • Reduce the spin speed for crease-sensitive fabrics
	30° Silk	Hand-washable fabrics that do not contain wool <ul style="list-style-type: none"> • wash tights and bras in a laundry net
	20° Hand wash	Fabrics made from hand-washable wool or wool blends <ul style="list-style-type: none"> • then dry the woollens in a dryer in a basket or dry them briefly in the dryer with "Wool finish" and then spread them out on a towel to finish drying in the air
	30° Wool	Machine-washable fabrics made from wool or wool blends Wool seal with the addition "does not felt" or "machine-washable" <ul style="list-style-type: none"> • drying as described above
	20° Cotton	Jeans, jumpers, T-shirts <ul style="list-style-type: none"> • lightly soiled coloured cottons, not temperature-resistant dyed
	30° Quickwash	Jeans, jumpers (sportswear), swimming trunks, towelling <ul style="list-style-type: none"> • unsoiled cottons, blended fabrics and synthetic fibres that are slightly creased • new fabrics (removal of production residues)
	90° Cotton	Bed and table linen, kitchen linen, towels, aprons, underwear <ul style="list-style-type: none"> • white and colourfast made of cotton and linen
	70° Autoclean	Machine cleaning, without laundry and detergent <ul style="list-style-type: none"> • drum and caustic tank are cleaned hygienically and odours are prevented. • If you wish to use cleaning agents, we recommend using Schulthess Machine Cleaner R 163. This enables you to achieve optimal results. • Start the Autoclean programme. Immediately press the light bar next to Forward. The programme jumps to the washing programme step. Add approx. 50 ml of machine cleaner to COMPARTMENT II during the water intake
	Rinse, spin	For rinsing hand-washed fabrics Rinsing and spinning <ul style="list-style-type: none"> • observe the spin speed for crease-sensitive fabrics
	Spin	spin only <ul style="list-style-type: none"> • observe the spin speed for crease-sensitive fabrics

Homeclean



60° Wiping cloths

Wiping cloths, mops

- cottons, blended fabrics or microfibres
- with pre-rinse. Fill **COMPARTMENT II** with washing powder



40° Curtains

Curtains labelled as machine-washable

- fabrics made from blended fabrics or synthetics
- deselect the spin cycle for crease-sensitive curtains
- with pre-rinse. Fill **COMPARTMENT II** with washing powder



60° Down, pillows

Duvets, pillows, jackets, sleeping bags

Feather, down, synthetic or natural hair filling

- push the air out of the laundry before washing so that the down is wetted more quickly
- with pre-rinse. Fill **COMPARTMENT II** with washing powder



60° Bed linen

Duvet covers, fitted sheets, bedspreads

- cottons or blended fabrics



60° Towelling

Bath towels, hand towels, bathrobes

- cottons



60° Table linen

Tablecloths and napkins

- Cotton, linen and blended fabrics
- Pre-wash selectable

If you wash at low temperatures too often in succession, there is a risk of germs building up in the washing machine.

Businesswear



40° Shirts, blouses ironed finish

Shirts or blouses made of cotton or blended fabric

- Pre-treat collars and cuffs depending on how dirty they are
- Hang up laundry immediately after washing and air dry. This usually eliminates the need for ironing.



40° Jeans

Jeans, chinos, jackets

- cottons or blended fabrics
- wash denim with the inside facing out



30° Jumpers

Jumpers

- cottons or blended fabrics

Softcare



30° Angora

angora, jumpers, scarves

- then dry the laundry in a dryer in a basket or dry it briefly in the dryer with "Wool finish" and then spread it out on a towel to finish drying in the air



30° Cashmere

cashmere, merino jumpers, scarves

- then dry the laundry in a dryer in a basket or dry it briefly in the dryer with "Wool finish" and then spread it out on a towel to finish drying in the air



30° Lingerie

Hand-washable fabrics that do not contain wool

- Wash tights and bras in a laundry net

Activewear



30° Sportswear

sports and leisure jackets, weatherwear, ski suits, fleeces, T-shirts, shorts

- modern fabrics made of microfibre or with a high microfibre content, e.g. GoreTex or SympaTex
- do not use fabric softener



30° Impregnate

sports and leisure jackets, weatherwear, ski suits, table linen

- for impregnating modern fabrics made of microfibre or with a high microfibre content (e.g. GoreTex or SympaTex) to achieve a water- and dirt-repellent effect



30° Trainers

Trainers, sneakers

Washable trainers and casual shoes made of cotton or synthetic materials, no leather items

- with pre-rinse.
- Fill **COMPARTMENT II** with washing powder
- Follow the manufacturer's care instructions
- Then dry the shoes in a dryer in a basket or air dry

Antibac



40° Cotton Antibac

Jeans, jumpers, T-shirts, trousers, socks

- coloured cottons



60° Cotton Antibac

Bed linen, aprons, jeans, towels, shirts, underwear

- coloured cottons, linen



90° Cotton Antibac

Bed and table linen, kitchen linen, towels, aprons, underwear

- white and colourfast made of cotton and linen



40° Easy care Antibac

Outerwear, shirts, blouses, T-shirts, socks

- easy care cottons, blended fabrics or fabrics with synthetic fibres



**60° Easy care
Antibac**

Outerwear, shirts, blouses, bed and table linen

- easy care cottons, blended fabrics or fabrics with synthetic fibres



**90° Easy care
Antibac**

Bed and table linen, towels, underwear

- easy care cottons, blended fabrics or fabrics with synthetic fibres, white and colourfast

Babycare



70° Baby linen

Nappies, wrap-around bodysuits

- White and colourfast fabrics made of cotton
- with pre-rinse. Fill **COMPARTMENT II** with washing powder



40° Baby linen

Bodysuits, rompers, playsuits, pyjamas, shirts, trousers

- easy care cottons or non-iron blended fabric



40° Playing pieces

LEGO, Duplo, etc.
without electrical parts

- Wash the playing pieces in a laundry net and then dry in a dryer in a basket or air dry
- disassemble assembled playing pieces before drying
- use liquid detergent for coloured laundry

PROGRAMME GROUPS

The programme groups described below are not available for every appliance.

Press the symbol buttons to call up the menu for the relevant programme group.

Favourites

The six programmes you use most frequently, including the selected options, are saved under the star button.

The **TIME PRESET**, **RINSE STOP** and **SOAK** options are not saved.

You can call up, select and start your favourite programmes quickly and conveniently using the star button.

You can also have your saved favourite programmes shown directly on the display when you switch on the appliance (see **SETTINGS / START MENU SELECTION**).

Deleting favourites

See **SETTINGS / DELETE FAVOURITES**.

Homecare

Homecare programmes with a high water level and low spin speeds are especially suitable for home fabrics made of blended fabrics and synthetics.

- Select **RINSE STOP** to avoid creasing at the end of the programme.
- Tie metal rollers or plastic sliders from curtains in a laundry net or bag (pillowcase).

CAUTION

Older curtains are often heavily bleached by the sun and are no longer resistant. Machine washing can therefore easily cause damage.

Businesswear

Ironing is generally not necessary for non-iron shirts and blouses.

- Hang up shirts and blouses after washing and allow them to air dry.
- Pre-treat heavily soiled collars and cuffs.

Softcare

Particularly gentle programmes for delicate fabrics made of angora, cashmere and silk.

Activewear

These programmes are suitable for weatherwear, sports and leisure jackets, as well as for modern fabrics made of microfibre or with a high microfibre content, e.g. GoreTex or SympaTex.

- Only use mild detergents, even for GoreTex and SympaTex.
- Pour liquid detergent into a dosing ball and place it in the drum with the laundry.

Notice

Do not use fabric softener. This can seal breathable membranes and thus impair subsequent waterproofing.

Pre-treat stains

Heavy stains, e.g. from grease, sun cream, lipstick or cosmetics, require suitable pre-treatment:

- Rub liquid mild detergent directly onto the stains with your fingers. Do not brush (risk of tissue damage!).

- Leave the detergent to work for approx. five minutes and then wash the laundry as usual.

Impregnate

To prepare the laundry for impregnation, it must first be washed clean and rinsed with cleaning vinegar:

- Load the laundry.
- Pour in the detergent.
- Fill **COMPARTMENT**  with cleaning vinegar up to the **MAX** mark.
- Run the **SPORTSWEAR** programme.
- Start the **IMPREGNATE** programme immediately after finishing the wash programme
- Add 350 ml of impregnating agent to **COMPARTMENT II** at the same time as the water is added.
- After impregnation, dry the laundry completely at the highest temperature permitted for these fabrics.

Notice

Microfibre fabrics, GoreTex and SympaTex may only be treated with specially designed impregnating agents. Otherwise there is a risk of the breathable membranes becoming blocked.

Antibac

The Antibac programmes can largely kill harmful germs and mites and flush out allergens particularly well.

Notice

The **TEMPERATURE** programme option is not available for this programme.

Babycare

The "70° Baby laundry" programme is pre-rinsed with cold water at the start of the programme.

- So pour the detergent into **COMPARTMENT II**.

PROGRAMME OPTIONS

The options described below are not available for every appliance.

By selecting one or more options, a wash programme can be tailored to the specifics of the laundry.

- Programme options are only active for the duration of the current wash programme.
- Longer-term adjustments can be made in the settings (**SETTINGS** menu) and remain active until they are changed again.

Notice

The **EXPRESS**, **PREWASH** and **INTENSIVE** programme options are mutually exclusive, which is why only one of these options can be selected.

Express

Gentle and energy-saving washing of only lightly soiled fabrics with reduced washing time.

- Fill with a maximum of half the specified amount of laundry.
- Use less detergent for small quantities of laundry or a low degree of soiling (see manufacturer's instructions on the packaging).

Prewash

For particularly heavily soiled laundry with heavy stains (blood, stains containing protein, etc.) and for professional laundry.

Pre-wash at approx. 30°C.

- Fill **COMPARTMENT I** with $\frac{1}{4}$ of the detergent quantity.
- Use powder detergent.

Intensive

For heavily soiled fabrics, especially for bleachable stains (e.g. fruit, coffee, tea, red wine, oil).

The washing time is extended.

Rinse +

The washing result can be improved by selecting an additional rinse cycle (for soft water areas or allergy sufferers).

Temperature

The temperature can be reduced in steps of 10°C. The current temperature is shown on the display.

- Reduce the preset wash temperature by pressing the light bar next to **TEMPERATURE**.

Notice

The temperature cannot be lowered for the **70° AUTOCLEAN** and **ANTIBAC** programmes.

Speed

Delicate laundry can be protected by selecting a lower spin speed. The current speed is shown on the display.

The speed can be reduced in steps of 100 rpm by pressing the light bar next to **SPEED**.

At 0 rpm there is no spin cycle and the laundry can be removed wet.

Notice

- Select a high speed if the laundry is to be subsequently machine dried or ironed. Well-drained laundry requires significantly less energy and time to dry.
At a higher spin speed, the noise emission is increased accordingly.

Rinse stop

For delicate laundry, creasing can be avoided by leaving the laundry in the final rinse water before spinning.

- The laundry can either be removed immediately or spun first (see **WASHING / ENDING PROGRAMME AFTER RINSE CYCLE HAS STOPPED**).

Soak

- Press the light bar next to **SOAK**.
- Input the desired soaking time by pressing the light bar (15 min increments, up to a maximum of 24 hours).
- Confirm input with **OK**.
- Press **START**.

The soaking time begins and the remaining time until the programme starts is displayed.

- Once the soaking time has elapsed, the selected programme starts automatically.
- Select **FORWARD** to start the wash programme immediately.

Notice

If the power is interrupted, the current soaking time is saved. The duration of the power interruption is not taken into account.

- Pour the soaking agent into **COMPARTMENT I** and the detergent into **COMPARTMENT II**.
- Soaking is not possible with Express and Antibac programmes.

Supersilent

With Supersilent, your washing machine washes extremely quietly.

The machine spins at a lower speed and the programme duration is extended.

- Use this function for washing during idle times.

Time preset

- With the **Time preset** option, you can set the start of the programme to a later time and thus adapt it to your individual habits (e.g. to take advantage of the low tariff for night-time electricity).

Notice

- Check that the time on the appliance is set correctly (see **SETTINGS / MENU SETTINGS / TIME**).
- If you are using liquid detergent, pour it into a dosing ball and place it in the drum with the laundry.

- First select the desired programme.
- Press the **TIME PRESET** symbol button.
- Input the date and time for the end of the programme by pressing the light bar (15 min increments, up to a maximum of 24 hours).
- Confirm input with **OK** and press **START**.

The preset time begins. The remaining time until the programme starts is displayed.

- Once the preset time has elapsed, the selected programme starts automatically.
- Press the **START** button again to cancel the preset time and start the wash programme immediately.

SETTINGS

Your washing machine has a default factory setting. You can adjust the settings to your individual requirements during initial operation or later. The settings can only be changed if no wash programme is running.

Change settings

- Press the light bar next to the **SETTINGS** symbol.
- Select **SETTINGS** by pressing the light bar.

The **SETTINGS** menu is displayed.

- Select the desired setting.
The **ARROW** buttons can be pressed to call up **ADDITIONAL MENU PAGES**.

Save changes

Press the **BACK** button (or no later than two minutes after the last input) to exit the **SETTINGS** menu.

Any changes made must be confirmed when exiting the menu.

Settings menu

You can find the individual factory settings for your machine in the consumption data in our download center.

Language

- **German**
-

The **ARROW** buttons can be pressed to call up additional menu pages.

- Select the desired language by pressing the light bar.

Date (factory-set)

The date can be set by pressing the light bar (press and hold for fast scrolling).
Confirm input with **OK**.

Time (factory-set)

The time can be set by pressing the light bar (press and hold for fast scrolling).
Confirm input with **OK**.

Summer/winter time

- **On**
- **Off**

The automatic changeover of the time display to summer time can be switched off.

Programme time display

- **Duration**

The remaining duration of the programme is shown on the display.

- **End**

The display shows when the programme will be finished.

Display brightness

- **50**

The intensity of the backlighting can be continuously adjusted from 20 to 100% by pressing the light bar (press and hold for fast scrolling).
Confirm input with **OK**.

Volume signal sound

- Off
- Volume 1
- Volume 2
- Volume 3
- Volume 4
- Volume 5

The buzzer signal sound can be regulated in 5 levels or muted.

Button sound

- On
- Off

The button sound can be switched off.

Additional rinsing

- Off
- On

Additional rinsing improves the rinsing result in soft water areas or for allergy sufferers.

The selected setting affects all wash programmes until the next time the setting is changed.

If additional rinsing is only to take place during the selected wash programme, select the **RINSE +** option.

Washing water level

- Normal
- Increased

With the "Increased" setting, the water level is increased during washing in all wash programmes.

Rinsing water level

- Normal
- Increased

With the "Increased" setting, the water level is increased during rinsing in all wash programmes.

Skin protection

- Off
- On

When set to "On", two additional rinse cycles are

carried out for all wash programmes, thus reducing skin allergies.

Soap wash programme

- Off
- On

Programme sequence optimised for the use of soap detergent with an additional rinse cycle to better rinse out the soap detergent.

The selected setting affects all wash programmes until the next time the setting is changed.

Spin speed

- Not reduced
- Reduced
- Reduced +

The spin speed can generally be reduced for all wash programmes (two levels).

Child lock

- Off
- On

The child lock prevents small children from starting, changing or deleting a programme.

Input with child lock switched on

- Press and hold the light bar at the top right (is not lit!).
- Press the desired button at the same time.

Delete favourites

- Select the function.
- The deletion of favourites must be confirmed.

Start menu selection

- Standard
- Favourites

You can display your saved favourite programmes directly in the start menu when you switch on the appliance.

Your favourite programmes are visible at first glance and can be selected as quickly as possible.

- For the selected start menu to be displayed, the appliance must be switched off and on again briefly after changing the setting.

Load measurement

- **On**
- **Off**

When load measurement is switched on, the amount of laundry loaded and a recommendation for the amount of detergent to be dosed are displayed. (Option: only for appliance version with load sensor)

Dirt sensor

- **Off**
- **On**
- **Rinse only**

If the dirt sensor is switched on during washing, the washing time is automatically extended in the event of heavy soiling.

Dirt is measured in cottons and easy care programmes.

(Option: only for appliance version with dirt sensor)

If the dirt sensor is switched on during rinsing, up to two additional rinsing cycles are carried out if the rinse water is very cloudy.

Notice

If liquid detergent is used or tabs are placed directly in the drum, the soil sensor must be switched off during washing.

Appliance switch-off

Settings for automatic switch-off of the appliance:

- **Off**

The appliance remains switched on at all times.

- **On**

The appliance switches off when the programme has finished or if no further operations are carried out after the appliance has been switched on.

Standard setting for appliances with Aquastop (water inlet hose with overflow protection).

• Standby +

A few minutes after the end of the programme or if no further operations are carried out after switching on the appliance, all displays go out. Power consumption is reduced to an absolute minimum, while the safety functions remain active.

Standard setting for appliances without Aquastop (water inlet hose "without" overflow protection).

Waking up the machine

- Press the **ON/OFF** button.

Crease protection

- **Off**
- **30 min**
- **6 h**

At the end of the programme, a crease protection phase (loosening up the laundry) can be set for 30 minutes or 6 hours.

Automatic door opening

- **Off**
- **On**

When the function is switched on, the door opens automatically at the end of the programme.

Factory settings

The settings can be reset to the default factory settings (delivery status).

- Confirm the reset with **YES**.

All settings are reset.

The saved favourite programmes are also deleted

Cool down

- **Off**
- **On**

Damage to older drain pipes can be avoided by adding cold water at the end of the wash cycle for hot-water laundry.

To avoid creasing, the machine is always cooled down in easy care programmes, regardless of the setting made here.

Grid connection reduced

- **No**
- **Yes**

If the connection power is reduced, the programme times will be longer.

Notice

- Appliances with **230 V 10 A CONNECTION** are set to reduced connection power as standard

PREPAID CARD / WASHMASTER CARD

Selecting the programme

- Select the desired washing programme (see **WASHING / SELECT AND START PROGRAMME**).

The display shows the selected programme with programme duration, maximum load, selected options and the relevant programme price.

Starting the programme

- Press **START** and hold the card close to the washMaster symbol on the control and display panel.

The programme price is debited and the new credit balance is displayed.

The programme starts after the payment has been made.

- Remove the card.

Credit balance insufficient

If the credit balance on the card is less than the programme price, the following message is displayed.

The difference can be paid with a second card.

Loading the card

If this message is displayed, the credit balance must be topped up before the next wash.

Prepaid card

Prepaid cards cannot be topped up by the user alone.

- Please contact the caretaker or the management.

Notice

Topping up prepaid cards is described in the operating instructions for the payment system (No 538 800).

washMaster card

The washMaster card can be topped up by making a transfer into the relevant washMaster account.

Two options are available:

- Use the payment slips provided for a bank transfer.
- Top up the card via the mobile app or pay directly via the mobile app. You can find detailed instructions at: <https://help.washmaster.ch>. You must register to use the mobile app.

Scan the QR code to download the app.



CLEANING AND MAINTENANCE

Cleaning the appliance

WARNING

Risk of electric shock!

- Switch off the power supply to the machine before starting cleaning.
- Never spray the appliance with water.
- Do not use a steam cleaner.

Notice

Solvents can damage appliance parts, develop toxic vapours and are explosive.

Do not use cleaning agents containing solvents.

- Do not use abrasive cleaning agents.
- Never scratch or scrape with sharp objects.
- Clean the housing and control panel with soapy water or a solvent-free, non-abrasive cleaning agent.

Notice

- Never use steel wool!

Cleaning the drum

- Remove rust stains caused by metal parts that have been left behind using a chlorine-free cleaning agent (observe the description of the ingredients on the packaging).

Descaling the appliance

The formation of limescale depends on the water hardness. If the detergent is dosed correctly, descaling is generally not necessary. If you decide to descale anyway, follow the manufacturer's instructions on the packaging.

Notice

Acids contained in descaling agents can attack appliance parts and discolour the laundry.

Checking the water inlet hose

To prevent water damage, the condition of the hoses should be checked by a specialist every five years for appliances without an Aquestop valve.

Frost protection

If your washing machine is located in a room where there is a risk of frost, all water residue must be removed from the drain pump and the inlet and outlet hoses immediately after each use.

Emptying the water inlet hose

Notice

Before unscrewing the water inlet hose, the pressure in the hose must be relieved:

- Close the water tap.
- Start any programme and cancel it again after approx. 40 seconds. This relieves the pressure in the hose.

Appliance without Aquestop

- Disconnect the power supply.
- Unscrew the inlet hose from the tap.
- Drain the water into a container.
- Screw the hose back on.

Appliance with Aquastop

- Unscrew the inlet hose from the tap.
- Hold the hose as high as possible.
- Start any programme and cancel it again after approx. 40 seconds. In this way, the water drains from the hose into the washing machine.
- Screw the hose back on.

Emptying the drain pump

See **EMERGENCY EMPTYING**.

Cleaning the detergent drawer

Removing the detergent drawer

- The drawer can be pulled out completely by pressing lightly on the coloured tab in the middle compartment.

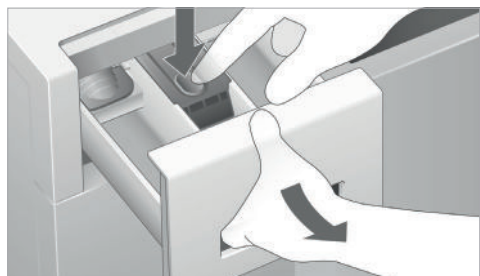

Cleaning the inside (weekly)

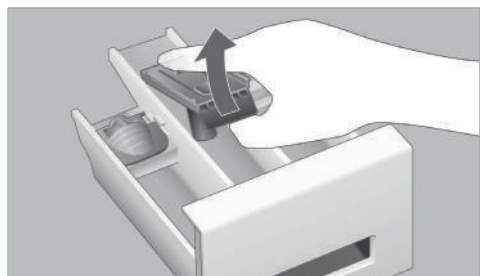

- Loosen the insert in **COMPARTMENT**  by lifting it slightly and remove it.

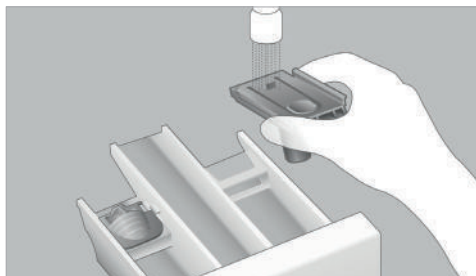

- Clean the insert and the detergent compartments under running water.

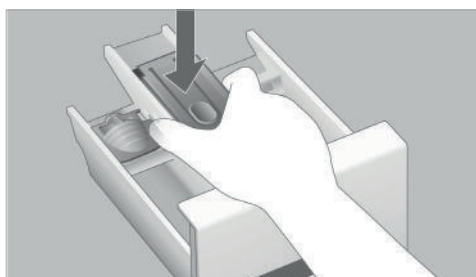

- Replace the insert in the middle compartment.

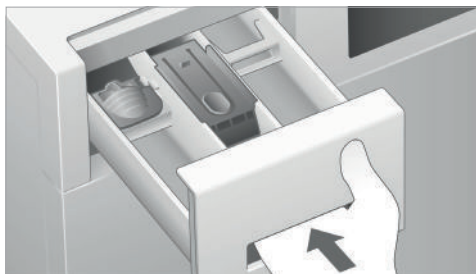

- Push the detergent drawer back in.

Emergency emptying

Emergency emptying must be carried out in the following cases:

- The message **CHECK WATER DISCHARGE** is displayed.
- The pump is blocked by foreign objects (e.g. buttons, clips, fluff).
- The water is not being pumped out.

WARNING

Risk of injury!

- Switch off the power supply to the machine and turn off the water tap.

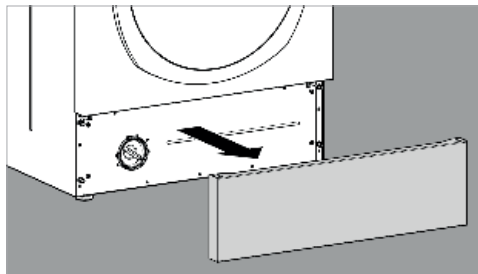

- Open the maintenance flap at the front of the washing machine.

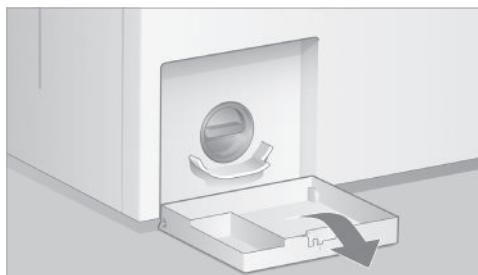

WARNING

Risk of scalding!

The suds can get very hot when washing at high temperatures. Let the suds cool down before emptying.

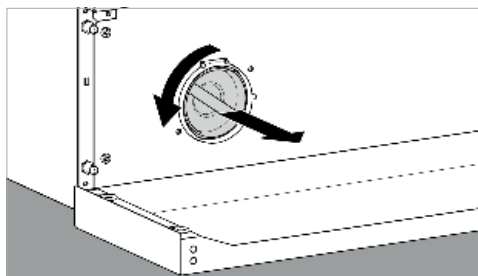

- Unscrew the pump cover until the residual water starts to drain out.

Notice

Up to 20 litres of water can leak out when emptying! Loosen the pump cover carefully and only gradually.

- Once all the remaining water has been drained, the pump cover can be unscrewed completely.
- Clean the inside of the pump. Remove any foreign objects and fluff deposits. The pump blades must be able to rotate freely.
- Screw the pump cover back on.

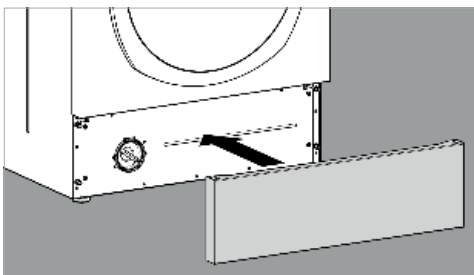

- Close the maintenance flap.
- Switch the power supply back on.
- Select any wash programme and cancel it as soon as the water supply has finished. This prevents detergent from entering the drain system unused during the next wash.

Cleaning the filters in the water inlet

The filters in the screw connections of the inlet hose can become blocked.

Check and clean the filters in the following cases:

- The message **CHECK WATER INLET** is displayed.
- Despite the tap being open, not enough water is running in.

Notice

Before unscrewing the inlet hose, the pressure in the hose must be relieved:

- Close the water tap.
- Start any wash programme and cancel it again after approx. 40 seconds. This relieves the pressure in the hose.

Appliance without Aquastop

- Unscrew the inlet hose from the tap.
- Clean the filter inside under running water.

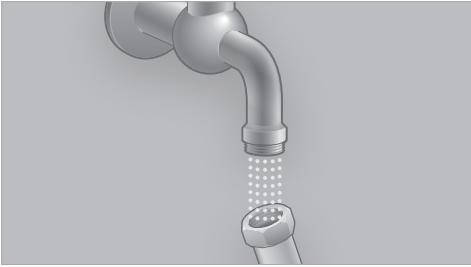

- Reconnect the hose.
- Unscrew the other end of the hose from the back of the appliance.

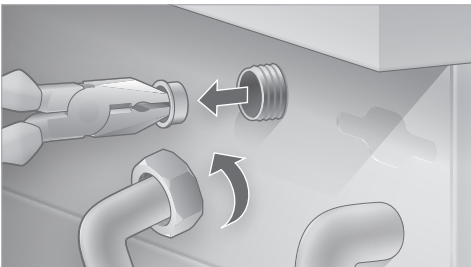

- Pull out the filter with pliers and clean it under running water
- Replace the filter and reconnect the hose.
- Briefly open the tap to check that the connection points are tight.
- Close the water tap.

Appliance with Aquastop

- Disconnect the power supply.
- Unscrew the inlet hose from the tap.

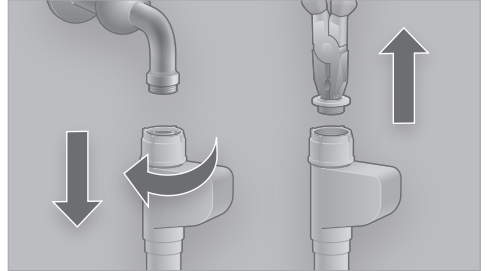

- Pull out the filter with pliers and clean it under running water
- Replace the filter and reconnect the hose.
- Briefly open the tap to check that the connection point is tight.
- Close the water tap.

PROBLEMS

WARNING

Improper repairs can result in serious accidents, damage and operation malfunctions!

Do not make any changes, manipulations or attempts at repair, especially not using tools such as screwdrivers or similar.

ERROR MESSAGES

Child lock active

- Hold the bar in the upper right (is not lit!) and at the same time press the desired button.

Door open

- Press the door shut until you hear the lock click into place.
- Press the start button to start the programme.

The door cannot be locked despite repeated attempts.

- Press the **OPEN THE DOOR** button.
- Check whether an item of laundry is jammed in the door.
- Press the start button after you have corrected the problem.

Check water inlet

- Open the water inlet and press the start button.

Filter in water inlet is blocked.

- Clean the filter (see **CLEANING AND MAINTENANCE / CLEANING FILTER IN WATER INLET**).
- Press the start button after you have corrected the problem.

Interruption in water supply.

Check drain

- Check whether the outlet hose is clogged.
- Press the start button after you have corrected the problem.

Foreign objects are blocking the drain pump.

- Clean the pump (see **CLEANING AND MAINTENANCE / EMERGENCY EMPTYING**).
- Press the start button after you have corrected the problem.

The water discharge at the installation site is clogged.

- Carry out an emergency emptying (see **CLEANING AND MAINTENANCE / EMERGENCY EMPTYING**) and clean the drain siphon (built-in siphon).
- Press the start button after you have corrected the problem.

- The position of the outlet hose is too high (the maximum pumping height is 1 m above ground).

Excessive imbalance

The laundry could not be spun due to excessive imbalance.

- Press the light bar next to **CONTINUE** to restart the spin cycle.

The laundry could not be spun despite pressing the light bar next to **CONTINUE**.

- Open the door and loosen the laundry.
- Press the light bar next to **CONTINUE** again.

	<p>The laundry could not be spun, even after loosening.</p> <ul style="list-style-type: none"> • Press the light bar next to CANCEL. <p>The wash programme is interrupted.</p>
	<p>Notice</p> <ul style="list-style-type: none"> • Mix large and small laundry items. • Avoid loading the drum with individual heavy laundry items.
Too much foam Programme extended	<p>The washing machine has detected foam and taken adequate measures. The spin cycle of the laundry could be completed.</p> <ul style="list-style-type: none"> • In future, reduce the detergent quantity.
Too much foam Programme cancelled	<p>The wash programme has been cancelled due to extremely heavy foaming.</p> <ul style="list-style-type: none"> • Repeat the wash programme without adding any detergent. • In future, reduce the detergent quantity. • If required, use washing powder instead of liquid detergent.
Please wait till it is pumped out	<ul style="list-style-type: none"> • Too much water in the washing machine. The water is being pumped out. <p>A lot of foam can be seen in the door glass: Foaming in the machine is too strong.</p> <ul style="list-style-type: none"> • In future, reduce the detergent quantity.

ERROR MESSAGES

Prepaid card / washMaster card

Turn card	<ul style="list-style-type: none"> • Turn the card over.
Balance too low Insert another card	<p>The credit balance is not sufficient.</p> <ul style="list-style-type: none"> • Use a loaded card.
Wrong user number or card type	<p>The card used is not authorised.</p> <ul style="list-style-type: none"> • Contact the responsible support person.
Card cannot be read	<p>The card cannot be read.</p> <ul style="list-style-type: none"> • Reinsert the card or contact the responsible support person.
Wrong laundry room number	<p>The card is not authorised for this laundry room.</p>
Reinsert the card	<p>The card could not be read.</p> <ul style="list-style-type: none"> • Reinsert the card
Balance soon to be used up	<p>The balance is only sufficient for the selected wash programme.</p>

MACHINE OPERATION

Appliance does not start when pressing the ON/OFF button

- Check the power supply to the appliance (wall switch/mains plug).
- Check whether all the fuses are intact or whether the circuit breaker has tripped.

Mains blocking (usually around midday)

- Operate the appliance after the mains blocking has ended.

-
- If the washing machine does not start despite the correct power supply, contact customer service.

The washing machine will not start

- Press **START**.
- If the programme does not start despite pressing the start button, contact customer service.

Notice

If a time preset is selected, the programme only starts after the preset time has elapsed.

Loading door cannot be opened

Wait until the **PROGRAMME END** message is displayed.

- Press **OPEN THE DOOR**.

RINSING STOP option is selected.

- To proceed further, see **WASHING / ENDING PROGRAMME WITH RINSING STOP**.

Appliance defect.

- Contact customer service (see **CUSTOMER SERVICE**).

Power failure.

- Open the door manually.

Drum lighting does not work

LED defective.

- For safety reasons, the LED may only be replaced by a specialist.

ERROR MESSAGES F--

“Error F --” is displayed

- Acknowledge the error message with **OK**. The machine restarts.
- Press the door shut.
- Select a programme again and press **START**.



“Error F --” is displayed again despite programme restart

- Acknowledge the error message with **OK**.
- Interrupt the power supply for one minute (switch the main switch off and on again). As soon as the display lights up, the appliance is ready for operation again.
- Press the door shut.
- Select a programme again and press **START**.

“Error F --” is displayed again after interruption of the power supply

- Note the error message.
- Disconnect the water inlet and switch off the main switch.
- Contact customer service (see **CUSTOMER SERVICE**).

WASHING AND WASHING RESULT

Detergent residue in the detergent compartment	<p>FLAP A in COMPARTMENT II is in the position for liquid detergent.</p> <ul style="list-style-type: none">• Push the lid up and back.
Damp or clumpy detergent	<ul style="list-style-type: none">• Dry the detergent compartment before filling it with washing powder.• Pour liquid or compact detergent into a dosing ball and place it in the drum with the laundry. <p>Thick fabric softener remains in COMPARTMENT .</p> <ul style="list-style-type: none">• Dilute thick fabric softener with approx. 100 ml of water and pour the mixture into COMPARTMENT .• Fill the compartment up to the "max" mark at most.• Clean COMPARTMENT  (see CLEANING AND MAINTENANCE).
Water not visible during the wash	<p>No error.</p> <ul style="list-style-type: none">• The water is in the appliance below the visible area.
Laundry does not get clean	<p>Laundry was soiled more heavily than expected.</p> <ul style="list-style-type: none">• Remove stains from the laundry before washing.• Wash at the highest temperature permitted for these fabrics.• Select a stronger wash programme.• Use sufficient detergent (follow the manufacturer's guidelines).
Detergent residues on the laundry	<p>Detergent residues are not due to a poor rinsing result from your washing machine. Phosphate-free detergents can leave insoluble residues that tend to deposit as light-coloured stains on the laundry.</p> <ul style="list-style-type: none">• Brush out the detergent residues after drying or rinse the laundry again (see PROGRAMME OVERVIEW / PROGRAMMES MAIN MENU / RINSE SPIN).• Use a wash programme with a higher water level (easy care) and liquid detergent.• Use additional rinse cycles.
Grey residues on the laundry (grease lice)	<p>If soiling is caused by ointments, fats or oils, the normal dosage of detergent is sometimes not sufficient.</p> <ul style="list-style-type: none">• Use more detergent the next time you wash.• Select the maximum temperature permitted for the fabrics.
Grey stains on the laundry	<p>Grey stains can be caused by cosmetics or fabric softener and may have already got onto the laundry outside the appliance before washing.</p> <ul style="list-style-type: none">• Some stains can be washed out after soaking in liquid detergent.
Laundry is hard or board-like	<ul style="list-style-type: none">• Use fabric softener in the next wash cycle if you leave the laundry to air dry.• Dry the laundry in a dryer.
Drum and tank are dirty (scraps of paper, oil, etc.)	<p>Tissues or similar objects were not removed from the laundry before washing.</p> <ul style="list-style-type: none">• Start the 70° AUTOCLEAN programme (or 60° COTTON) to clean the drum and tank (without laundry and detergent).

Laundry smells unpleasant (e.g. after perspiration or decay)	<p>Laundry has been washed too long at only a low temperature and contains too many odour-producing germs.</p> <ul style="list-style-type: none"> Wash the laundry at 60°C or the maximum permitted temperature for the fabrics from time to time, and use heavy-duty detergent (with bleach). <p>Use special low-temperature detergent when you wash at 20/30°C.</p>
Odour accumulation in the machine	<p>Odour-producing germs have accumulated in the washing machine or in the drain.</p> <ul style="list-style-type: none"> Clean the machine and drain from time to time using the 70° AU-TOCLEAN (or 60° COTTON) cleaning programme (without laundry and detergents).
Laundry becomes matted (pilling)	<p>Delicates (e.g. woollens) can become matted if subjected to excessive mechanical stress.</p> <ul style="list-style-type: none"> In future, select a gentle programme suitable for delicates (wool, hand wash, etc.).
Tear and hold formation, fibre abrasion	<p>It might be a case of normal wear or mechanical damage of fabrics that already existed before washing.</p> <ul style="list-style-type: none"> Remove any foreign objects from the laundry before washing. Close hooks, zips and Velcro fasteners before washing. Wash sensitive laundry in a laundry net.

FOAM AND LEAKAGE

Some foam remains at the end of the programme	<p>Some detergents tend to produce a lot of foam, but this does not affect the rinse results.</p>
Too much foam visible during washing Foam fills the entire drum	<p>Too much detergent was used.</p> <ul style="list-style-type: none"> Mix approx. 200 ml fabric softener with approx. ½ litre water. Pour the fabric softener/water mixture into COMPARTMENT II of the detergent drawer. Repeat the procedure if necessary. Use less detergent in future.

Foam escapes from the detergent drawer during washing, rinsing or spinning

Too much detergent was used.

- Stop the programme by pressing the **CANCEL** button.
There are two ways to solve the problem:

Option A

- Mix approx. 300 ml fabric softener with approx. 1 litre of water.
- Start the previously selected wash programme (it may take a few minutes before the appliance is released for the selection of a new programme).
- After the water intake has ended, immediately jump to the **FINISH** programme step with **FORWARD**.
- Pour the fabric softener/water mixture into **COMPARTMENT I** of the detergent drawer.

The programme should now end as usual and the spinning process should take place.

- Afterwards repeat the wash programme, but without adding any detergent.

Option B

- Wait for approx. 1 hour.
Then press **START** and use **FORWARD** to jump to the **SPIN** programme step. As a rule, the laundry can now be spun and the programme runs to the end as normal.
- Repeat the wash programme without adding any detergent.

-
- Use less detergent in future.
 - If required, use washing powder instead of liquid detergent.

Puddles or water stains form on the floor

Too much detergent was used.

- Use less detergent in future.
-
- Check that the inlet and outlet hoses are tight and have been fitted correctly.
-

SPINNING AND NOISE

Pump noise

No error! The noises when the drain pump starts up and “drains” are normal.

Multiple spins

The appliance has recognised an imbalance and eliminated it by spinning it several times.

Poor spin result

The appliance has detected an imbalance that could not be corrected.
If the laundry is underloaded or critical laundry items, such as bathroom mats, are present, the laundry cannot be sufficiently distributed.
In this case, the spin speed is specifically reduced to protect the appliance from overstraining.

Vibrations and high noise levels
Appliance “wanders” when spinning

- The transport securing devices have not been removed.
- Follow the notes in the installation instructions.
-

Appliance feet were not fixed during installation.

- Realign the appliance using a spirit level and secure the appliance feet in accordance with the installation instructions.
-

Programme duration extended

No error.

- The machine has detected foam and taken adequate measures.
 - The machine has detected an imbalance and taken adequate measures.
 - The machine has detected excessive soiling and/or cloudy rinse water and extended the programme.
-

CUSTOMER SERVICE

Schulthess Maschinen AG produces washing machines and dryers of outstanding quality with a proverbially long service life. It is for this reason that Schulthess carefully selects, tests and assembles parts, components and materials.

Should error messages or faults nevertheless occur, you will find lots of helpful information online at www.schulthess.ch/de/kundenservice, such as detailed operating instructions, tips and tricks as well as answers to the most frequently asked questions (FAQ).

Our service number 0844 888 222 can be contacted from Monday to Friday, 08:00 to 12:00 and 13:00 to 17:00.

Please make a note of error message F -- as well as the product and appliance number.

Register your appliance or take advantage of the extended warranty, which offers you many benefits. You can also find the relevant information at **www.schulthess.ch/de/kundenservice**.

EG-KONFORMITÄTSERKLÄRUNG EC-DECLARATION OF CONFORMITY CE-DÉCLARATION DE CONFORMITÉ CE-DICHIARAZIONE DI CONFORMITÀ

No. 24/21

Wir erklären in alleiniger Verantwortung, dass das elektrotechnische Erzeugnis
We declare under our sole responsibility that the electrical product
Nous déclarons sous notre seule responsabilité que le produit électrique
Noi dichiariamo sotto la nostra esclusiva responsabilità che l'apparecchio elettrico

Waschmaschine / Washer / Machine à laver / Lavatrice **WA14EFH**

auf das sich diese Erklärung bezieht, mit den folgenden Normen übereinstimmt:
to which this declaration relates is in conformity with the following standards:
auquel se réfère cette déclaration est conforme aux normes :
al quale si riferisce la presente dichiarazione é conforme alle norme:

EN 50571:2013 + A1:2018

EN 55014-1:2017

EN 55014-2:2015

EN 60335-1:2012 + A11:2014 + A13:2017 + A1:2019 + A14:2019 + A2:2019

EN 60335-2-7:2010 + A1:2013 + A11:2013 + A2:2019

EN 61000-3-2:2019

EN 61000-3-3:2013

EN 61000-3-3:2013/AMD1:2017

EN 62233:2008

gemäss den Bestimmungen folgender Richtlinien
following the provisions of Directives
conformément aux disposition des Directives
conformemente alle disposizioni e Direttive

2014/30/EU Directive relating to electromagnetic compatibility

2006/42/EC Machinery Directive

Wolfhausen, 01-03-2021

Hersteller / Manufacturer / Fabricant / Il produttore

Schulthess Maschinen AG

Landstrasse 37, CH-8633 Wolfhausen

EG-KONFORMITÄTSERKLÄRUNG EC-DECLARATION OF CONFORMITY CE-DÉCLARATION DE CONFORMITÉ CE-DICHIARAZIONE DI CONFORMITÀ

No. 25/21

Wir erklären in alleiniger Verantwortung, dass das elektrotechnische Erzeugnis
We declare under our sole responsibility that the electrical product
Nous déclarons sous notre seule responsabilité que le produit électrique
Noi dichiariamo sotto la nostra esclusiva responsabilità che l'apparecchio elettrico

Waschmaschine / Washer / Machine à laver / Lavatrice **WA14MFH**

auf das sich diese Erklärung bezieht, mit den folgenden Normen übereinstimmt:
to which this declaration relates is in conformity with the following standards:
auquel se réfère cette déclaration est conforme aux normes :
al quale si riferisce la presente dichiarazione é conforme alle norme:

EN 50571:2013 + A1:2018

EN 55014-1:2017

EN 55014-2:2015

EN 60335-1:2012 + A11:2014 + A13:2017 + A1:2019 + A14:2019 + A2:2019

EN 60335-2-7:2010 + A1:2013 + A11:2013 + A2:2019

EN 61000-3-2:2019

EN 61000-3-3:2013

EN 61000-6-2:2019

EN 62233:2008

gemäss den Bestimmungen folgender Richtlinien
following the provisions of Directives
conformément aux disposition des Directives
conformemente alle disposizioni e Direttive

2014/30/EU Directive relating to electromagnetic compatibility

2006/42/EC Machinery Directive

Wolfhausen, 01-03-2021

Hersteller / Manufacturer / Fabricant / Il produttore

Schulthess Maschinen AG

Landstrasse 37, CH-8633 Wolfhausen



For environmental reasons, we now only print very little.
Further documents and information on your machines
can be found in the download centre or in the informa-
tion area of your machines at
www.schulthess.ch/en (see QR code).

Schulthess Maschinen AG
Alte Steinhäuserstrasse 1, 6330 Cham ZG
Phone + 41 (0) 55 253 51 11
www.schulthess.ch

